

INSTANT UPRIGHT

Span 300-serien Bruksanvisning



ALTERNATIV 1:
2m BUNNRAMME



ALTERNATIV 3:
VX BUNNRAMME



ALTERNATIV 2:
1m BUNNRAMME

BETEGNELSE

SPAN300 Dobbel bredde
EN1004 - 3 - 8/12 - XXCD
SPAN300 Enkel bredde
EN1004 - 3 - 8/8 - XXCD

CEN-betegnelse av denne
bruksanvisningen

EN 1298 — IM — NOR

⚠ ADVARSEL

**STÅ ALDRI PÅ EN
UBESKYTTET PLATTFORM**

SIKRE ARBEIDSBELASTNINGER OG ARBEIDSHØYDER

Sikker arbeidsbelastning på hvert nivå av plattformen er 360 kg jevnt fordelt, uavhengig av om én eller to plattformer er installert. Derfor, selv om to plattformer er installert ved siden av hverandre, skal total kumulativ last ikke overstige 360kg fordelt.

Den totale belastning på rullestillaset bør ikke overstige 720 kg. Normal maksimal plattformhøyde for innendørs bruk er 12m for dobbel bredde, og 8m for enkel bredde. For utendørs bruk, er maksimal høyde 8m for enkle og doble bredder.

MONTERINGSPROSESS

1. Forberedelse

- Plasser benjusteringer på hvert ben ca. 10 cm (4 tommer) fra foten av benet.
- Lås opp låseklemmer på alle rammer.
- Når de er installert, lås alltid låseklemmene.
- Sorter avstivere i horisontal- og diagonalstag -diagonalene er litt lengre.
- Lås opp låsetappene på avstiverne.

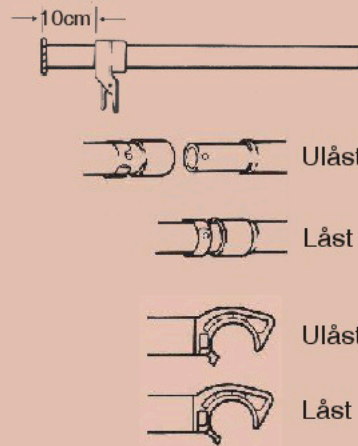

2. Fundament

- Punkt 1: Fest hjulene i benjusteringene.
- Punkt 2: pass på at låseklipsene ikke er låst til bunnrammer.
- Punkt 3: Fest hjul og benjusteringer til bunnrammen ved å skyve beinet inn i rammerøret. Dette bør gjøres manuelt uten bruk av verktøy.
- Punkt 4: Lås hjulene før du tar i bruk noen del av stillaset.



3. Lås plattformen

Plattformen låses fast ved hjelp av låsemekanismen ved kroken som vist på illustrasjonen til høyre.

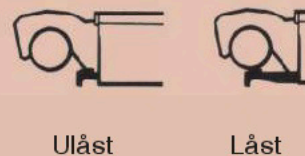

RÅD FOR BRUK AV STILLASET

- Vi anbefaler at minimum to personer monterer, demonterer og flytter stillaset.
- Sjekk at alle komponenter er til stede og i god stand.
- Sørg for at stillasets plassering er kontrollert med tanke på å forhindre farer under montering, demontering, flytting og bruk av stillaset. Vær særlig oppmerksom på bakkeforholdene og hvorvidt de er jevne eller skrånende, samt om det foreligger hindringer. Ta hensyn til vindforholdene på stedet. Grunnforholdene må være i stand til å understøtte stillaset.
- Man skal alltid klatre opp i stillaset på innsiden av konstruksjonen, og benytte stigen..
- Benjusteringer må kun brukes til å nivellere stillaset, og før stillaset flyttes må disse være så små som mulig (maks 150mm).
- Løfting av komponenter må gjøres inne i stillasets effektive grunnflate; komponentene heises vanligvis ved hjelp av et tau.
- Når stillaset flyttes må dette kun gjøres ved manuell kraft fra bunnen av stillaset.
- Når du flytter stillaset må du vise hensyn til farer i høyden, som f.eks. strømledninger.
- Hverken personer eller materiell kan være på stillaset når det flyttes.
- Pass opp for horisontale belastninger som kan medføre at stillaset blir ustabil. Den maksimale sidekraften er 20 kg.
- Når stillaset festes til en stiv struktur (bygning o.l.), fest en kobling til hver vertikalramme med 4m høydeintervaller. Sørg for at koblingene egner seg for aluminiumrør med 50mm diameter.
- Dersom du trenger et høyere stillas, ta kontakt med distributøren for å få de nødvendige ekstra komponentene. Ikke plasser kasser eller liknende i stillaset for å øke høyden.
- Stillaset skal ikke løftes eller henge fra noe, og må alltid ha bakkekontakt.
- Skadede komponenter eller komponenter fra andre stillasystemer må aldri brukes.
- Støtteben skal alltid være montert når dette er spesifisert. Bruk støtteben som vist på komponentlisten i henhold til stillasets høyde.
- Når vinden overstiger 4 på Beauforts skala, må alt arbeid i stillaset stanses.
- Hvis vinden er ventet å nå Beaufort styrke 6, fest stillaset til en fast struktur.
- Om vind med styrke 8 er prognosen, må stillaset demonteres eller flyttes i ly.

Vindhastigheter

Styrke	Topp mph	Topp km/h	Topp m/s	Veiledning
4	18	29	8,1	Laber bris - hever støv og løst papir
6	31	50	13,9	Liten kuling - vanskelig å bruke paraply
8	48	74	20,8	Sterk kuling - vanskelig å gå

STELL OG VEDLIKEHOLD

- Hold alt utstyr rent, spesielt detappene og festene i rammene. Endetapper bør enkelt passe inn i festene. Smøres med lettolje.
- Fjern smuss og maling fra benjusteringene med en fin børste, og smør benlåsene lett.
- Ikke slå eller hamre komponentene. Ikke kast eller slipp dem på harde overflater.
- Smør krokenes fjærmekanismer lett.
- Komponentene skal helst oppbevares stående under transport og lagring.
- Skadede deler må repareres eller erstattes. Ta kontakt med utstyrsleverandøren for å få råd.

DEMONTERING & FLYTTING AV TÅRNRULLESTILLAS

For å demontere stillaset, følg monteringsveiledningen i motsatt rekkefølge, og legg merke til følgende:

- For å fjerne rekkverksrammer eller avstivere, lås først opp kroken lengst vekk fra plattformluken.
- Når du sitter i luken, lås opp den nærmeste kroken og fjern avstiveren.

Før stillaset flyttes, må det forberedes.

- Vindstyrken bør ikke overstige 29 km / t (8,1 m / s).
- Benjusteringene må være minimert (maks 150 mm). Lås opp hjulene.
- Hev støttebenene akkurat nok til å komme over eventuelle hindringer.
- Dobbeltsekk at stillaset er tomt for både materiale og personer.
- Vær obs på hindringer over stillaset, som f.eks. strømledninger.
- Flytt stillaset manuelt ved å trekke og/eller skyve det ved foten - ikke bruk maskiner! Når stillaset er flyttet må det forberedes for bruk.
- Sjekk at alle hjulene og støttebenene er i kontakt med bakken.
- Sjekk at stillaset er nivellert (vatret) og juster bena etter behov.
- Lås hjulene.

3-T SIKKERHETSSTANDARD - GJENNOM LUKEN

Dette er en godkjent metode for stillaskonstruksjon som, hvis utført av en kompetent person, er i samsvar med gjeldende sikkerhetslovgivning.

Grunnleggende byggeprinsipper

- Installer alltid luken over stigen (hvis en slik er montert).
- Sørg for at luken er hengslet på utsiden av en dobbelbredde, og ikke mot midten.
- Nr plattformen er installert, klatre ved hjelp av godkjent adkomst, og sitt i lukeåpningen.
- Når du sitter, fest horisontalavstivere til rammene for danne rekkverk på begge sider av plattformen.
- Se monteringsanvisning for angitt plassering av rekkverk.
- To avstivere kreves normalt p hver side, men avstivende rammer kan benyttes på utsiden om det er ønskelig eller angitt i instruksjonene.
- Bare når plattformen er fullt beskyttet er det trygt å stå oppreist på den.

Demontering

- Lås opp avstiverens ende lengst vekk fra luken.
- Sitt gjennom luken som vist i figur 1.
- Ikke fjern avstiverne før du sitter i luken.
- **STÅ ALDRI PÅ EN UBESKYTTET PLATTFORM**



Fig 1

STØTTEBEN

Støtteben skal benyttes når dette er angitt, for å sikre den strukturelle stabiliteten til stillaset. I tillegg, er det viktig å merke seg ballasttabellen.

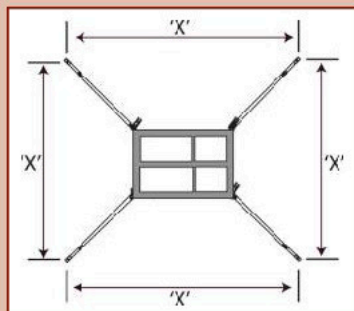
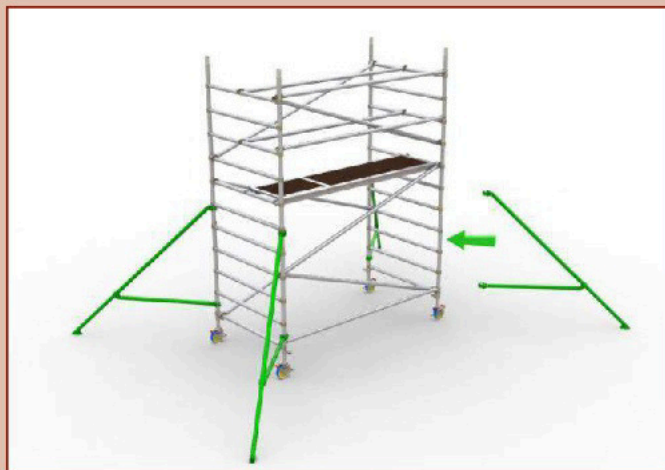

Fig 2



Fig 3



Fig 4

	2m enkel plattform	2.5m enkel plattform	3m enkel plattform
Teleskop-støtteben	x = 3,730mm	x = 3,929mm	x = 4,078mm
Lange støtteben	x = 4,440mm	x = 4,660mm	x = 4,841mm
	2m dobbel plattform	2.5m dobbel plattform	3m dobbel plattform
Teleskop-støtteben	x = 4,095mm	x = 4,333mm	x = 4,523mm
Lange støtteben	x = 4,792mm	x = 5,042mm	x = 5,252mm

Sørg alltid for at størrelsen på støttebenene er korrekt, slik at de gir optimal støtte til stillaset.

Stram de øvre klemmene over det sjette trinnet på hver av hjørnestolpene. Plasser den nedre klemmen over det nederste trinnet. Sørg for at den nedre armen er så horisontal som mulig. Plasser støttebenene slik at fotplatene er omtrent like langt fra hverandre, som vist i figur 2.

Juster uttriggerne og klemmene slik at støttebenene får bakkekontakt. Sørg for at låseklipsene er på plass, og når de er i riktig posisjon, stram dem hardt.

Ikke fjern støttebenene når stillaset plasseres mot en vegg, men flytt dem heller parallelt med veggen (figur 3).

Om stillaset plasseres i et hjørne, fjern støttebenet i hjørnet og plasser de to utenfor parallelt med veggen (figur 4).

ALTERNATIVE KONFIGURASJONER

Denne brukerveiledningen beskriver fremgangsmåten for å bygge stillas med stigerammer og enkle plattformer opp til arbeidsnivået. Alternative konstruksjoner kan utføres følgende:



Fig 4

To plattformer på hvert nivå

En andre plattform (luke ikke nødvendig) kan legges til på hvert mellomliggende plattformnivå.
(Kun for stillas med dobbel bredde)



Fig 5

Adkomst ved skråstilte stiger

Skråstilte stiger kan monteres for adkomst til hvert plattformnivå. Om skråstilte stiger benyttes, kan stigerammer byttes ut med standardrammer.
(Passer til både enkle og doble stillasbredder)

BYGGETABELLSJUSTERINGER



Hvis skråstilte stiger brukes, kan stigerammene byttes ut med standardrammer i de følgende byggetabellene.

Fig 6

Stillas med enkel bredde og skråstilte stiger.



Hvis det kreves plattformer med dobbel bredde på alle nivå, bør antall standardplattformer økes til det samme antallet som plattformer med luke

Fig 7

Stillas med dobbel bredde, to plattformer på alle nivå og skråstilte stiger.

Span400-systemet vist i ovennevnte grafikk

**DETALJERT
PRODUKTINFORMASJON**

**ALTERNATIV 1 - SPAN300
DW 2m BUNNRAMME**

Tabell over deler og mengder

Span 300 Dobbel bredde - 2m, 2,5m og 3m lengder til EN1004														
Plattformhøyde (m)	2m	3m	4m	5m	6m	7m	8m	9m	10m	11m	12m			
Arbeidshøyde (m)	4	5	6	7	8	9	10	11	12	13	14			
Stillashøyde (m)	3	4	5	6	7	8	9	10	11	12	13			
Stillasvekt i kg (2 m lengde) (SPAN300)*	106	153	177	203	228	260	284	311	335	361	385			
Stillasvekt i kg (2,5 m lengde)(SPAN300)*	119	171	197	229	254	292	318	349	375	407	432			
Stillasvekt i kg (3 m lengde) (SPAN300)*	130	186	213	248	275	316	343	378	405	440	467			
* Vektreduksjon (kg) for 300W stillas	9	11	14	17	20	22	26	28	31	34	37			
Merk: Oppgitte plattformhøyder inkluderer 150 mm benjustering for utjevning som kan økes eller reduseres														
Beskrivelse	Vekt (kg)													
7-trinns ramme SPAN300 (300W)	11,2	(8,4)		2	4	4	6	6	8	8	10	10	12	12
Rekkverkramme	4,0	(3,0)		2		2		2		2		2		2
Plattform m/ luke (2, 2.5, 3m)	14,0	18,0	20,0	1	2	2	2	3	3	4	4	5	5	6
Standard plattform (2, 2.5, 3 m)	14,0	17,0	20,0	1	1	1	1	1	1	1	1	1	1	1
Horisontalavstiver (2, 2.5, 3 m)	1,7	2,0	2,4	1	3	5	7	9	11	13	15	17	19	21
Diagonalavstiver (2, 2.5, 3 m)	1,8	2,2	2,5	4	6	8	10	12	14	16	18	20	22	24
Teleskop-støtteben (50430)	5,2				4	4	4	4						
Lange støtteben (9090)	6,8								4	4	4	4	4	4
Benjusteringer	1,1			4	4	4	4	4	4	4	4	4	4	4
Hjul / Fotplate	2,2			4	4	4	4	4	4	4	4	4	4	4
Fotlistsett (2, 2.5, 3m)	8,7	11,5	14,4	1	1	1	1	1	1	1	1	1	1	1
Siderekkverk (2, 2.5, 3 m)	3,8	4,4	5,2	2	2	2	2	2	2	2	2	2	2	2

Eksplovert diagram og referanseliste

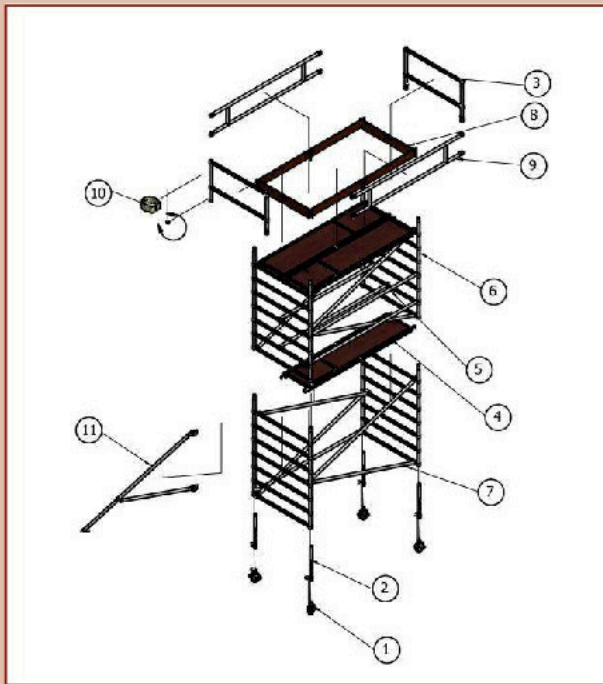

Stillasmontering

1. Hjul
2. Benjustering
3. Rekkverkramme
4. Plattform
5. Horisontalavstiver
6. 7-trinns ramme
7. Diagonalavstiver
8. Fotlist
9. Siderekkverk
10. Låseklips
11. Støtteben

STILLAS - DOBBEL BREDDE 6m - VIST FREMGANGSMÅTE ER FOR SPAN300 (LIKT FOR 300W)

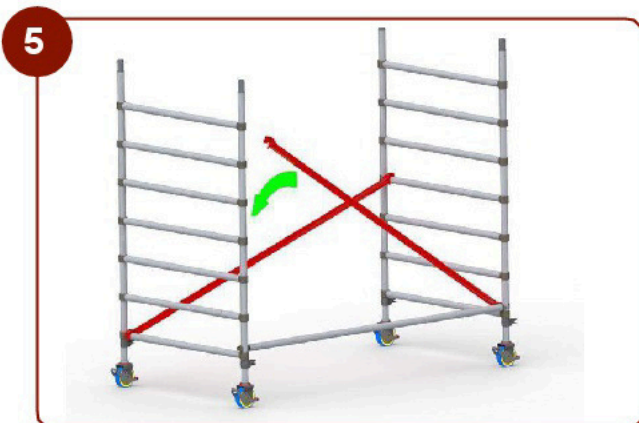
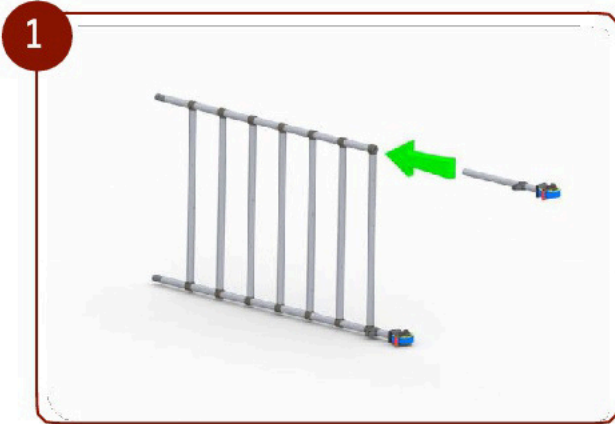

Stillas - dobbel bredde 6m

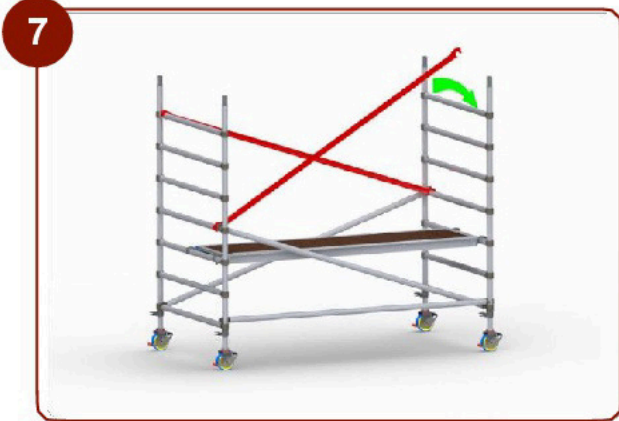

Stillas - dobbel bredde 6m

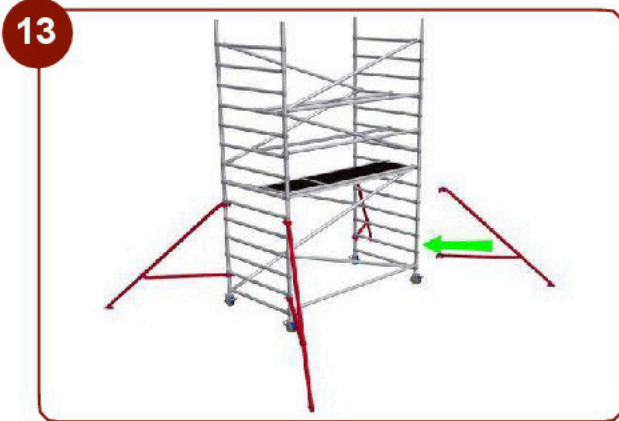

ADVARSEL
STÅ ALDRI PÅ EN
UBESKYTTET PLATTFORM

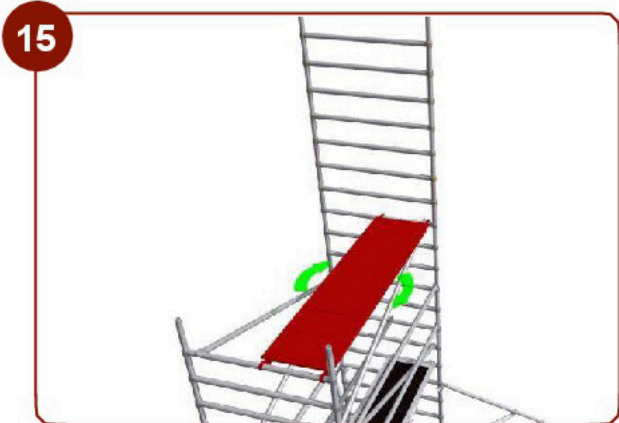

Stillas - dobbel bredde 6m

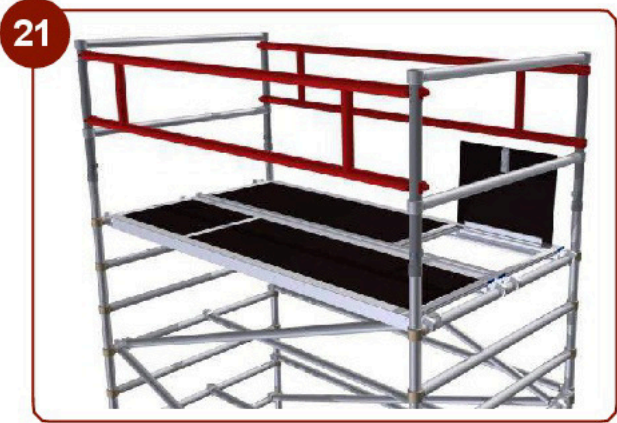
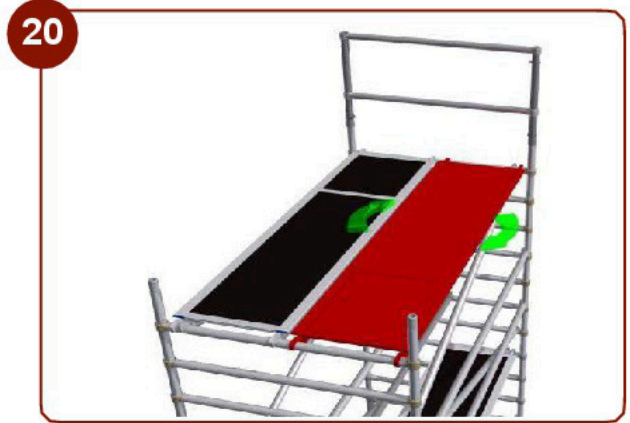

STILLAS - DOBBEL BREDDE 5m - VIST FREMGANGSMÅTE ER FOR SPAN300 (LIKT FOR 300W)

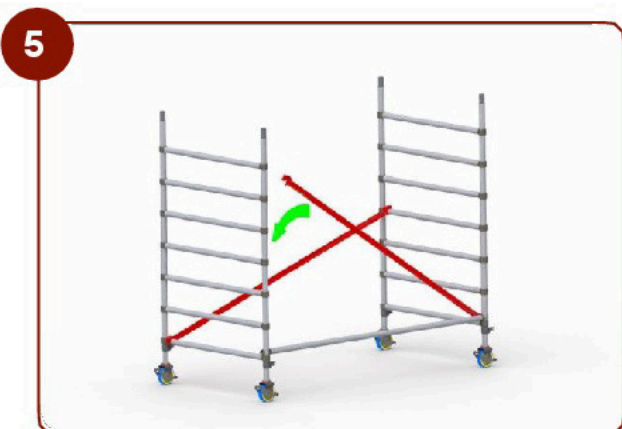
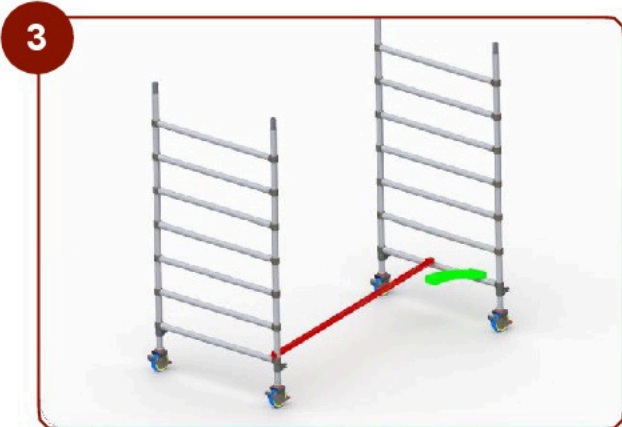

Stillas - dobbel bredde 5m

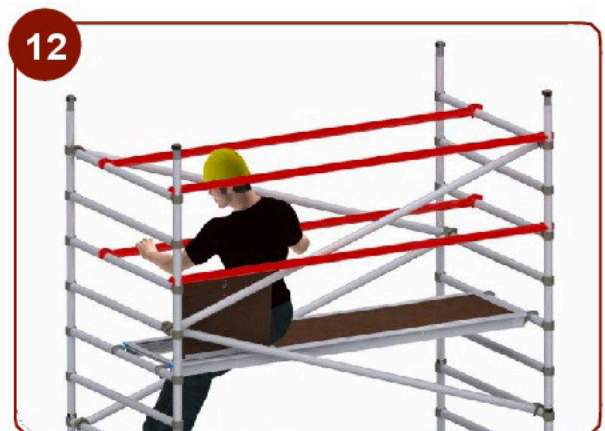
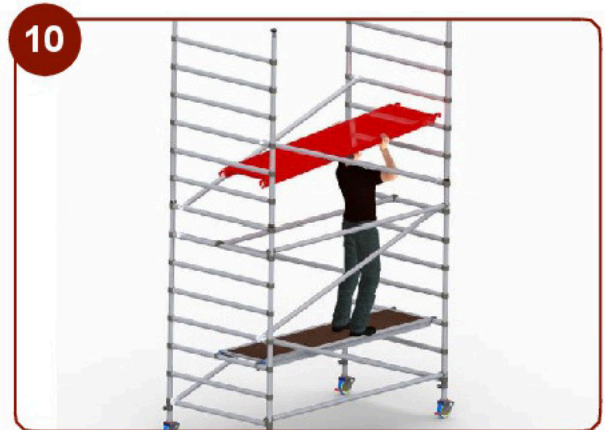
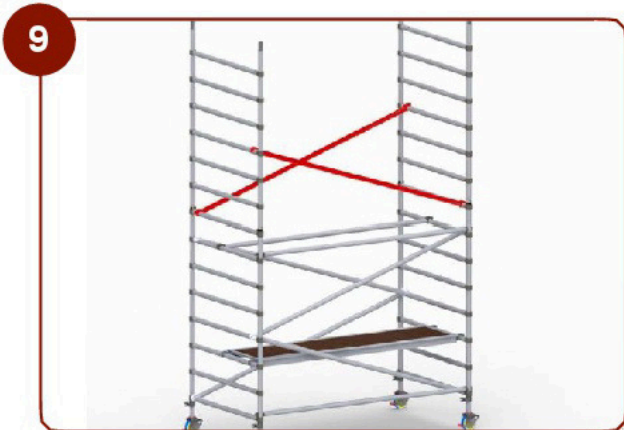

Stillas - dobbel bredde 5m

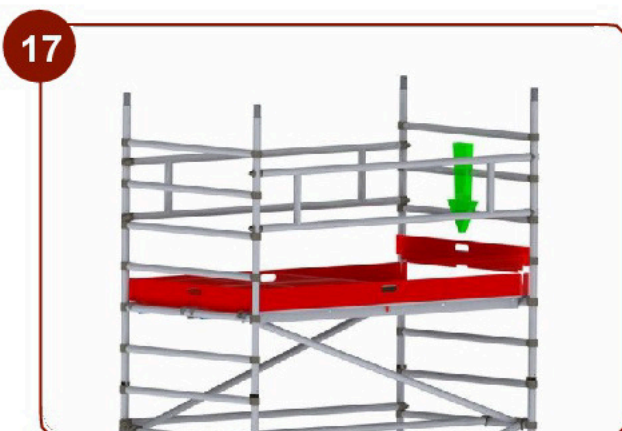
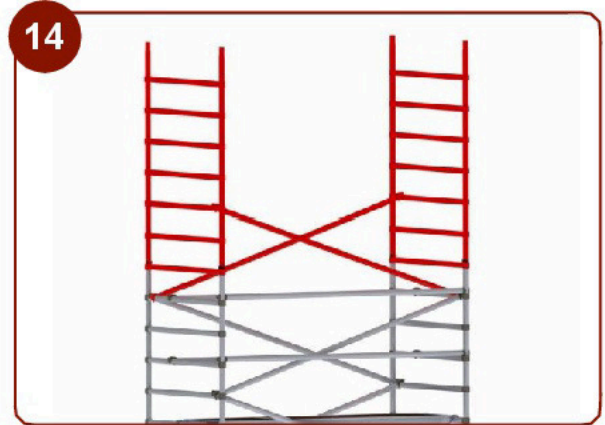
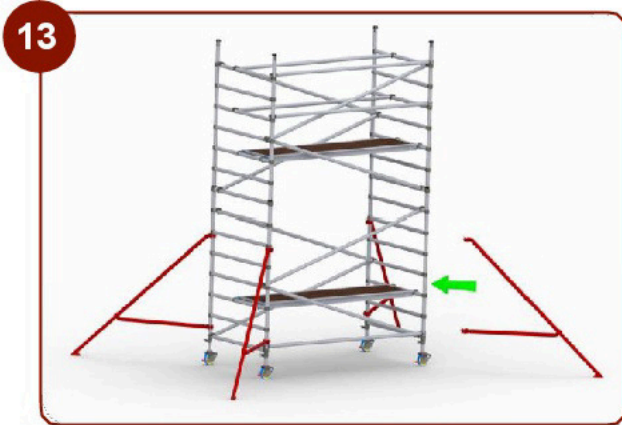

**DETALJERT
PRODUKTINFORMASJON**
Tabell over deler og mengder

**ALTERNATIV 1 - SPAN300
SW 2m BUNNRAMME**

Span 300 Enkel bredde - 2m, 2,5m og 3m lengder til EN1004

Plattformhøyde (m)	2m	3m	4m	5m	6m	7m	8m			
Arbeidshøyde (m)	4	5	6	7	8	9	10			
Stillashøyde (m)	3	4	5	6	7	8	9			
Stillasvekt i kg (2 m lengde) (SPAN300, 300W)	75	121	138	162	179	210	227			
Stillasvekt i kg (2,5 m lengde) (SPAN300, 300W)	83	134	151	181	199	235	253			
Stillasvekt i kg (3 m lengde) (SPAN300, 300W)	89	143	162	195	213	253	271			
Vektreduksjon (kg) for 300W stillas	9	11	14	17	20	22	26			
Beskrivelse	Vekt (kg)									
7-trinns ramme SPAN300 (300W)	8,5 (5,7)			2	4	4	6	6	8	8
Rekkverkramme	2,7 (2,0)			2		2		2		2
Plattform m/ luke (2, 2,5, 3m)	14,0	18,0	20,0	1	2	2	2	3	3	4
Horisontalavstiver (2, 2,5, 3 m)	1,7	2,0	2,4	1	3	5	7	9	11	13
Diagonalavstiver (2, 2,5, 3 m)	1,8	2,2	2,5	2	3	4	5	6	7	8
Siderekkerk (2, 2,5, 3 m)	3,8	4,4	5,2	2	2	2	2	2	2	2
Teleskop-støtteben(50430)	5,2				4	4	4	4		
Lange støtteben (9090)	6,8								4	4
Benjusteringer	1,1			4	4	4	4	4	4	4
Hjul /Fotplate	2,2			4	4	4	4	4	4	4
Fotlistsett (2, 2,5, 3m)	1,8	2,2	2,5	1	1	1	1	1	1	1

Eksplodert diagram og referanseliste

Merk: Oppgitte plattformhøyder inkluderer 150 mm benjustering for utjevning som kan økes eller reduseres

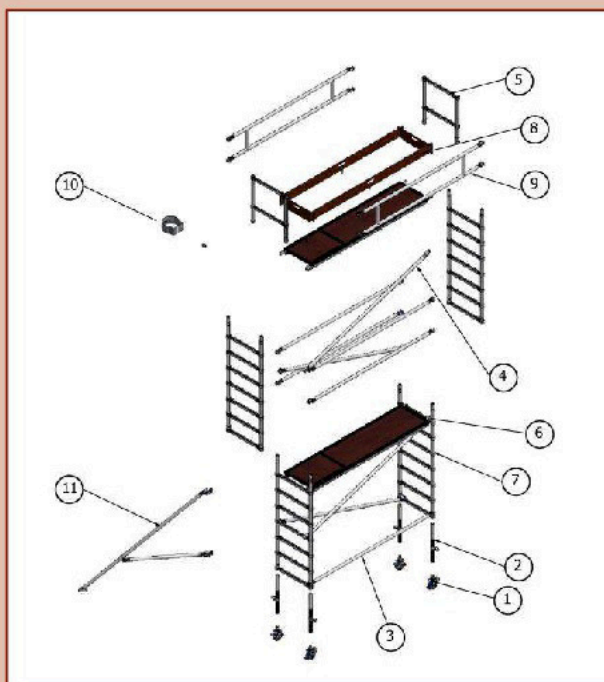

Stillasmontering

1. Hjul
2. Benjustering
3. Horisontalavstiver
4. Diagonalavstiver
5. Rekkverkramme
6. Plattform
7. 7-trinns ramme
8. Fotlist
9. Siderekkerk
10. Låseklips
11. Støtteben

Stillas - enkel bredde 6m - VIST FREMGANGSMÅTE ER FOR SPAN300 (LIKT FOR 300W)

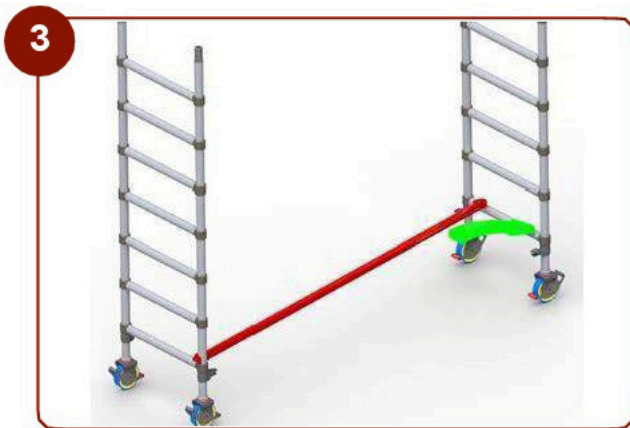
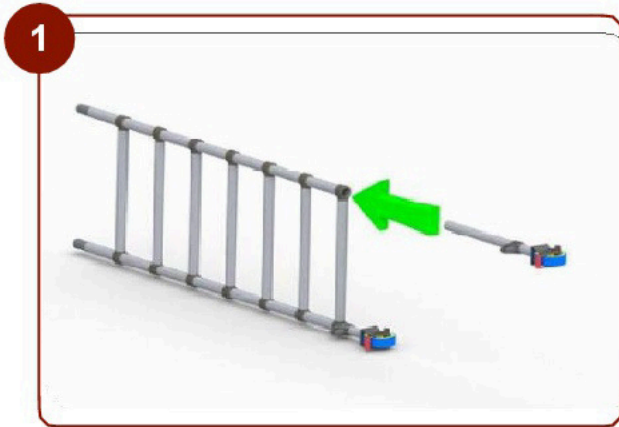

Stillas - enkel bredde 6m



Stillas - enkel bredde 6m

13



14



 **ADVARSEL**
STÅ ALDRI PÅ EN
UBESKYTTET PLATTFORM

15

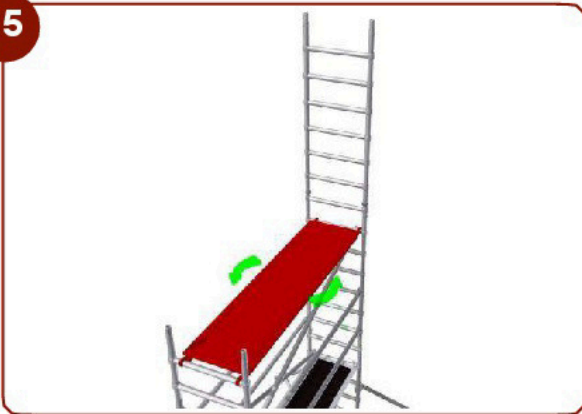

16



17



18



Stillas - enkel bredde 6m



Stillas - enkel bredde 6m

25



Stillas - enkel bredde 5m

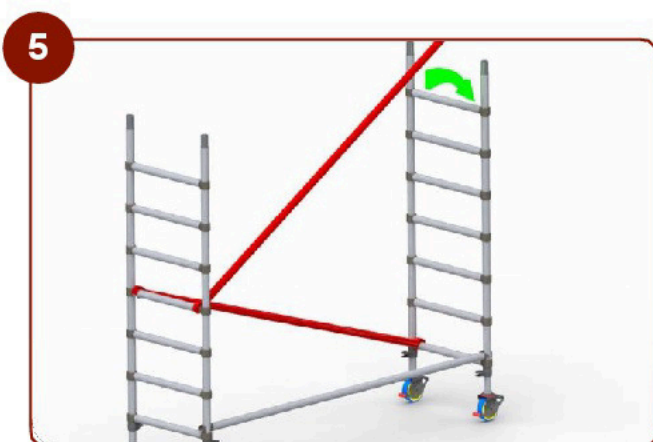
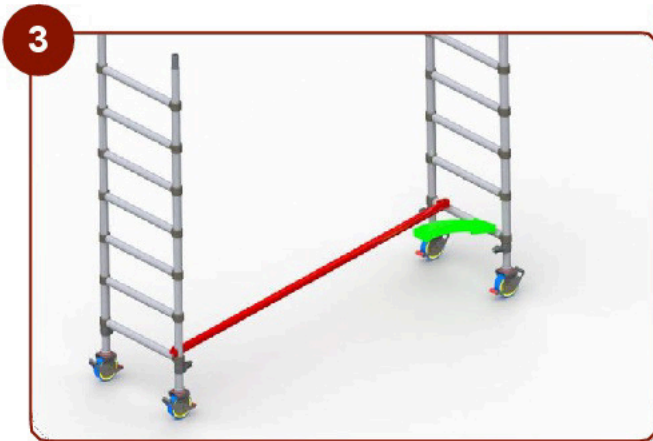
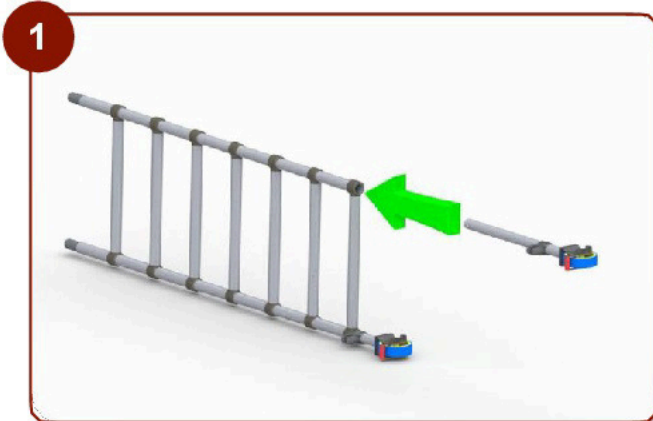

Stillas - enkel bredde 5m

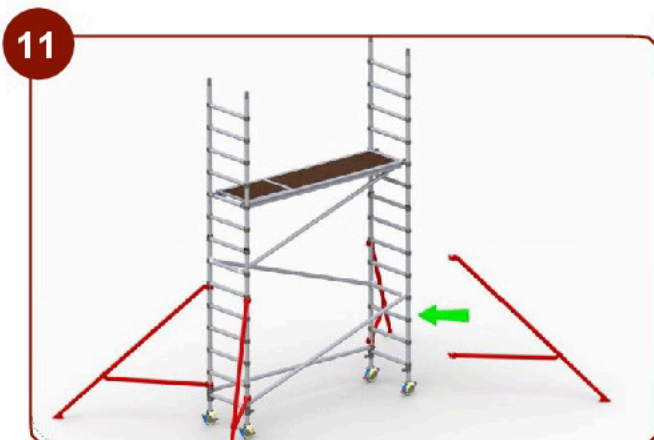
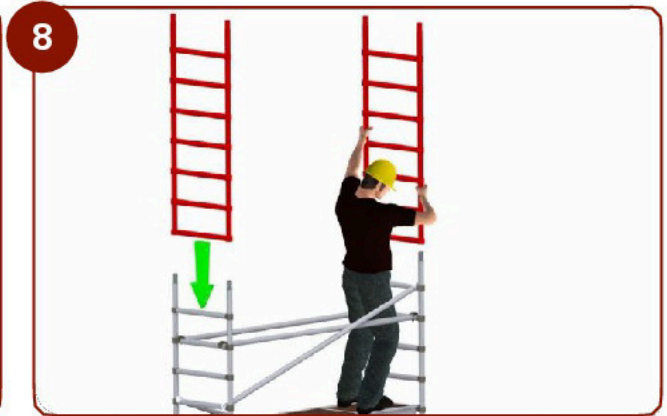

Stillas - enkel bredde 5m

13



14



15



16



17

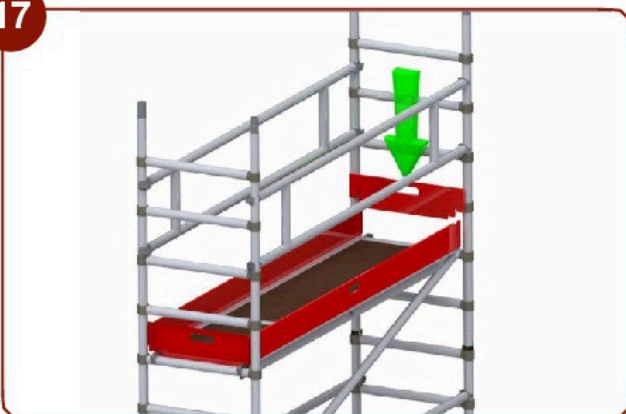

18



**DETALJERT
PRODUKTINFORMASJON**

Tabell over deler og mengder

**ALTERNATIV 2 -
SPAN300 DW 1m
BUNNRAMME**

Span 300 Dobbel bredde tårn - 2m, 2,5m og 3m lengder till EN1004

Plattformhøyde (m)	2m	3m	4m	5m	6m	7m	8m	9m	10m	11m	12m
Arbeidshøyde (m)	4	5	6	7	8	9	10	11	12	13	14
Stillas høyde (m)	3	4	5	6	7	8	9	10	11	12	13
Sillasvekt i kg (2 m lengde) (SPAN300)*	106	153	177	203	228	260	284	311	335	361	385
Stillasvekt i kg (2,5 m lengde)(SPAN300)*	119	171	197	229	254	292	318	349	375	407	432
Stillasvekt i kg (3 m lengde) (SPAN300)*	130	186	213	248	275	316	343	378	405	440	467
* Vektreduksjon (kg) for 300W Stillas	9	11	14	17	20	22	26	28	31	34	37

Merk: Oppgitte plattformhøyder inkluderer 150 mm benjustering for utjevning som kan økes eller reduseres

Beskrivelse	Vekt (kg)														
7-trinns ramme SPAN300 (300W)	11,2	(8,4)		2	4	4	6	6	8	8	10	10	12	12	
4 trinns ramme SPAN300 (300W)	8,5	(6,9)		2		2		2		2		2		2	
Plattform m/ luke (2, 2,5, 3m)	14,0	18,0	20,0	1	2	2	2	3	3	4	4	5	5	6	
Fast plattform (2, 2,5, 3 m)	14,0	17,0	20,0	1	1	1	1	1	1	1	1	1	1	1	
Horisontalavstiver (2, 2,5, 3 m)	1,7	2,0	2,4	1	3	5	7	9	11	13	15	17	19	21	
Diagonalavstiver (2, 2,5, 3 m)	1,8	2,2	2,5	4	6	8	10	12	14	16	18	20	22	24	
Teleskop-støtteben (50430)	5,2				4	4	4	4							
Lange støtteben (9090)	6,8								4	4	4	4	4	4	
Benjustering	1,1			4	4	4	4	4	4	4	4	4	4	4	
Hjul / Fotplate	2,2			4	4	4	4	4	4	4	4	4	4	4	
Fotlistsett (2, 2,5, 3m)	8,7	11,5	14,4	1	1	1	1	1	1	1	1	1	1	1	
Siderekker (2, 2,5, 3 m)	3,8	4,4	5,2	2	2	2	2	2	2	2	2	2	2	2	

Eksplovert diagram og referanseliste

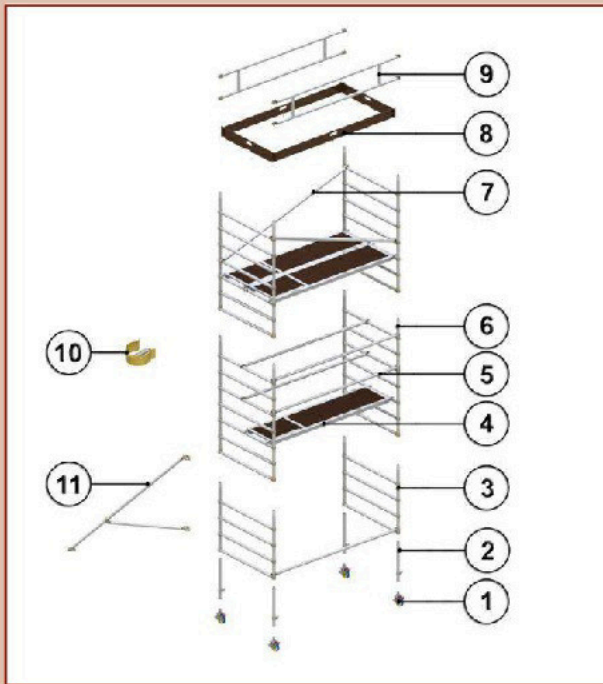

Stillasmontering

1. Hjul
2. Benjustering
3. 4-trinns ramme
4. Plattform
5. Horisontalavstiver
6. 7-trinns ramme
7. Diagonalavstiver
8. Fotlist
9. Siderekkverk
10. Låseklips
11. Støtteben

STILLAS - DOBBEL BREDDE 6m - VIST FREMGANGSMÅTE ER FOR SPAN300 (LIKT FOR 300W)

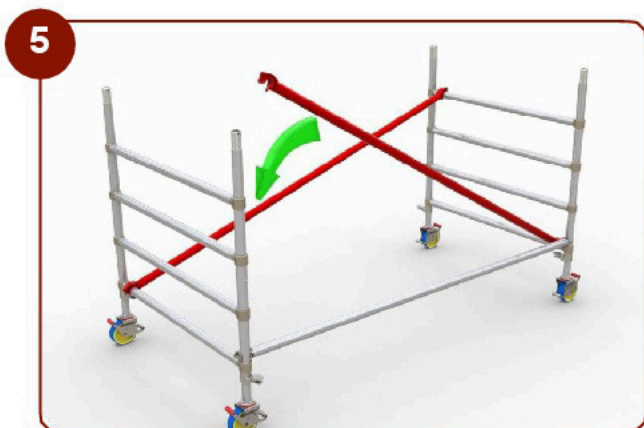
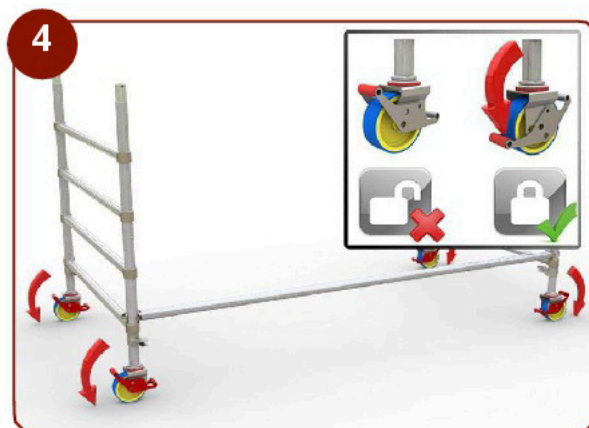
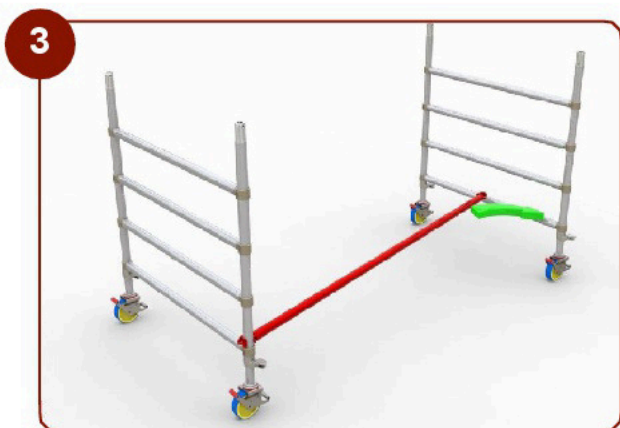
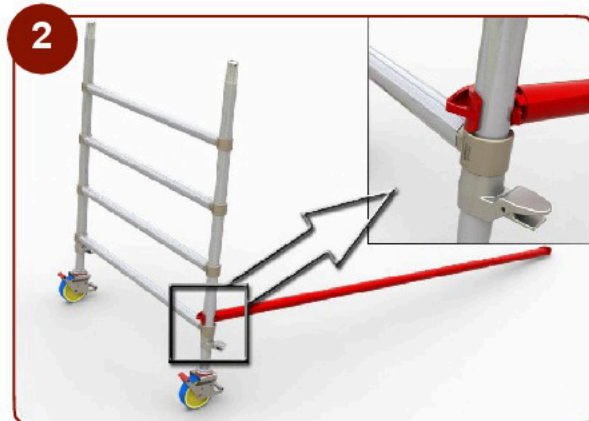
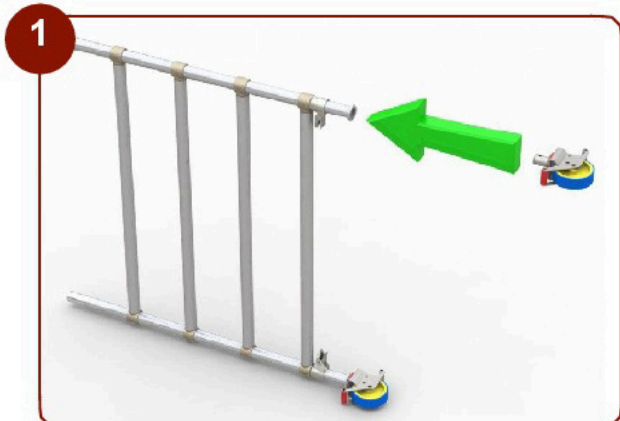

Stillas - dobbel bredde 6m

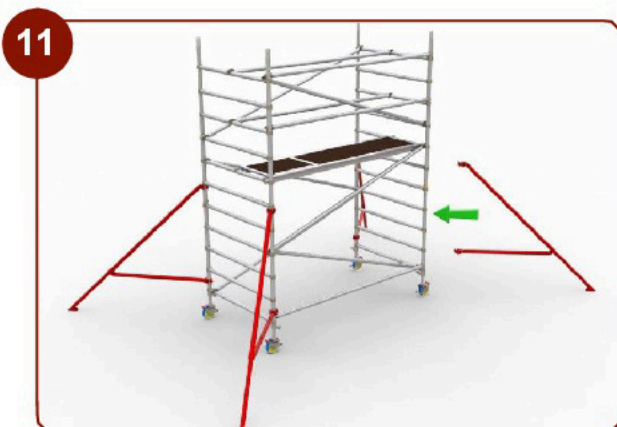
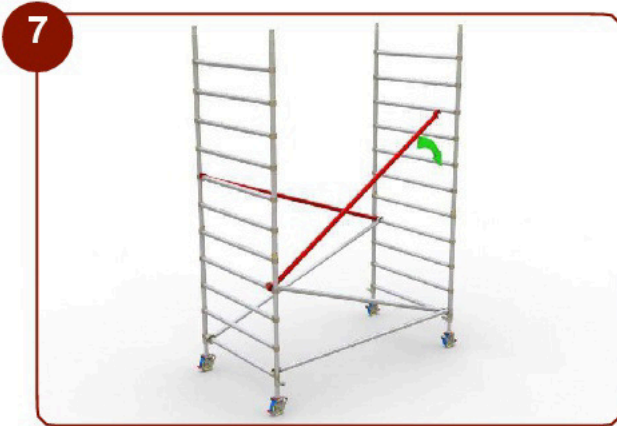

Stillas - dobbel bredde 6m

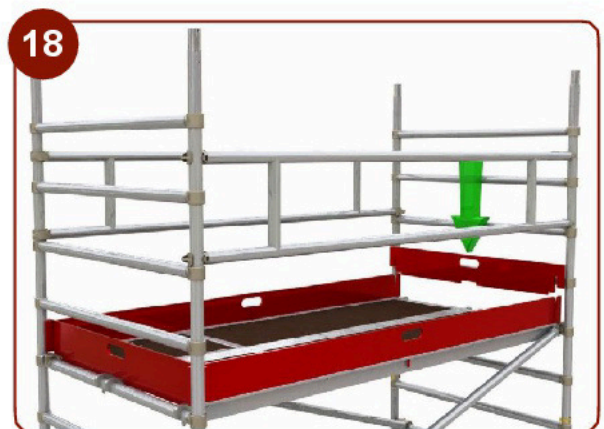
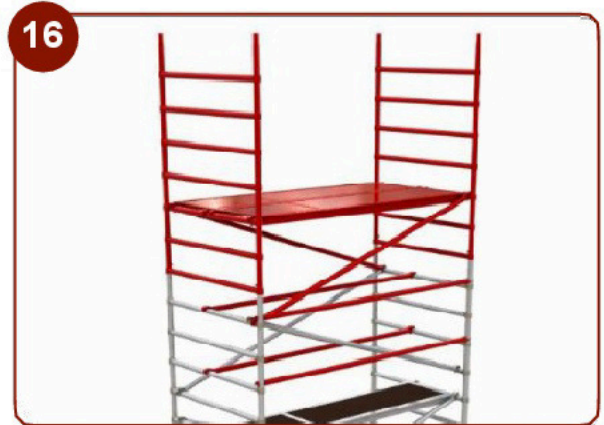

Stillas - dobbel bredde 6m

19



Stillas - dobbel bredde 5m

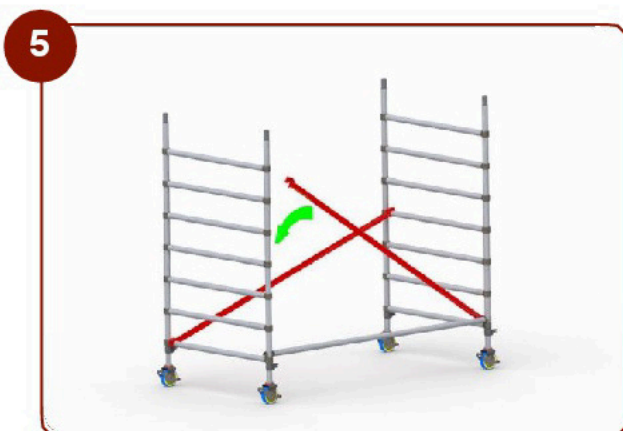
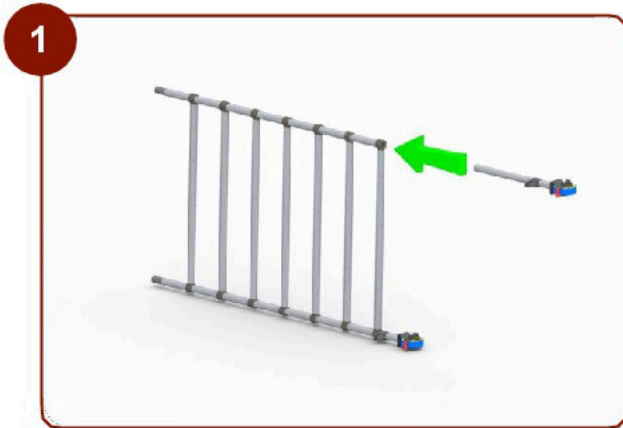

Stillas - dobbel bredde 5m

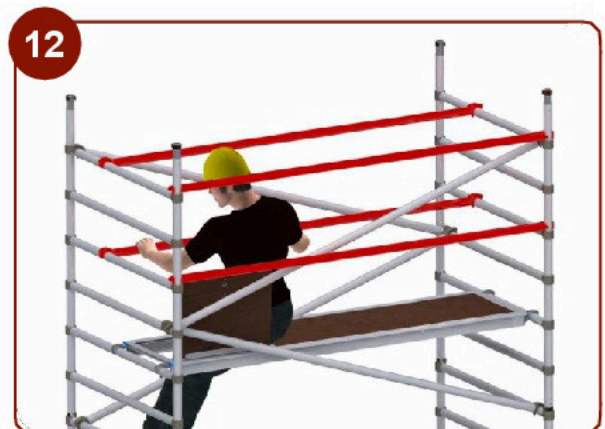
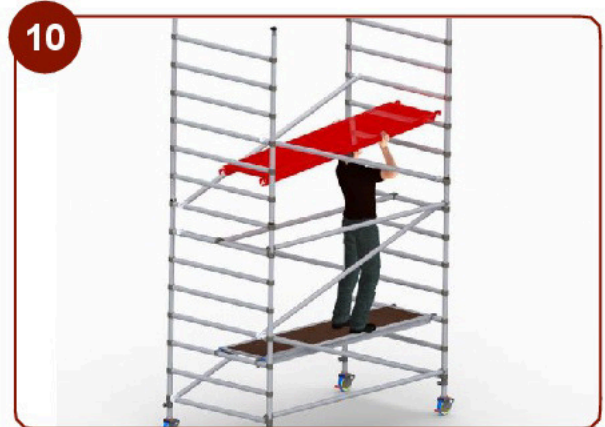
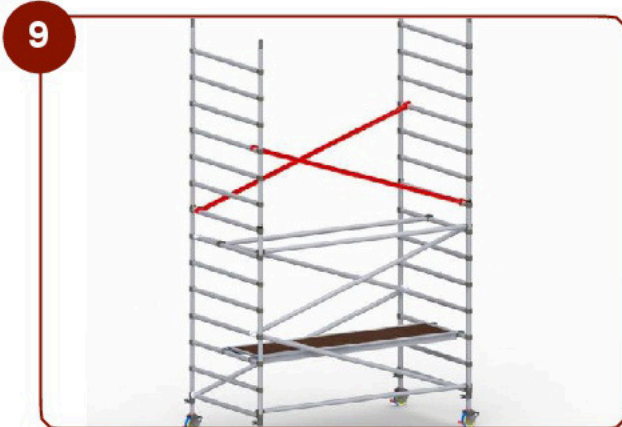

Stillas - dobbel bredde 5m

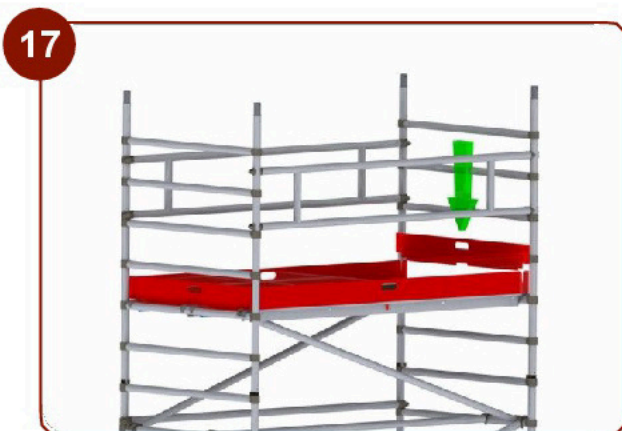
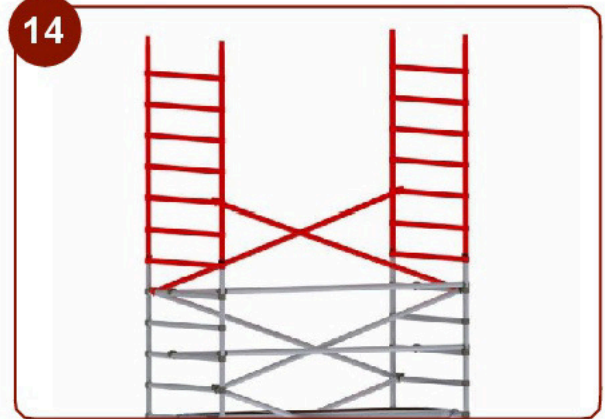
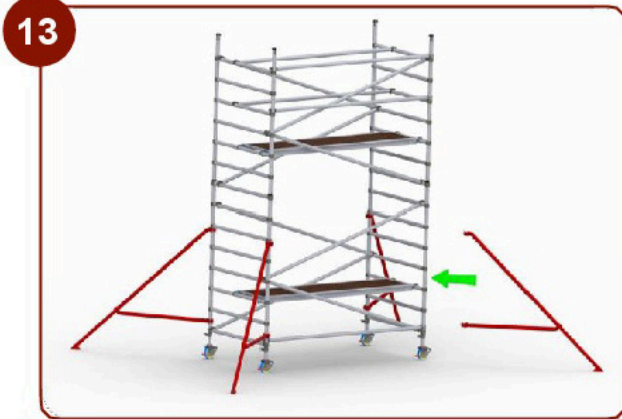

**DETALJERT
PRODUKTINFORMASJON**

Tabell over deler og mengder

**ALTERNATIV 2 -
SPAN300 SW 1m
BUNNRAMME**

Span 300 Enkel bredde - 2m, 2,5m og 3m lengder till EN1004										
Plattformhøyde (m)				2m	3m	4m	5m	6m	7m	8m
Arbeidshøyde (m)				4	5	6	7	8	9	10
Stillashøyde (m)				3	4	5	6	7	8	9
Stillasvekt i kg (2 m lengde) (SPAN300, 300W)				75	121	138	162	179	210	227
Stillasvekt i kg (2,5 m lengde) (SPAN300, 300W)				83	134	151	181	199	235	253
Stillasvekt i kg (3 m lengde) (SPAN300, 300W)				89	143	162	195	213	253	271
Vektreduksjon (kg) for 300W Stillas				9	11	14	17	20	22	26
Beskrivelse	Vekt (kg)									
7-trinns ramme SPAN300 (300W)	8,5	(5,7)		2	4	4	6	6	8	8
4-trinns ramme SPAN300 (300W)	5,7	(4,1)		2		2		2		2
Plattform m/ luke (2, 2,5, 3m)	14,0	18,0	20,0	1	2	2	2	3	3	4
Horisontalavstiver (2, 2,5, 3 m)	1,7	2,0	2,4	1	3	5	7	9	11	13
Diagonalavstiver (2, 2,5, 3 m)	1,8	2,2	2,5	2	3	4	5	6	7	8
Siderekkverk (2, 2,5, 3 m)	3,8	4,4	5,2	2	2	2	2	2	2	2
Teleskop-støtteben (50430)	5,2				4	4	4	4		
Lange støtteben (9090)	6,8								4	4
Benjustering	1,1			4	4	4	4	4	4	4
Hjul / Fotplate	2,2			4	4	4	4	4	4	4
Fotlistsett (2, 2,5, 3m)	1,8	2,2	2,5	1	1	1	1	1	1	1

Eksplodert diagram og referanseliste

Merk: Oppgitte plattformhøyder inkluderer 150 mm benjustering for utjevning som kan økes eller reduseres

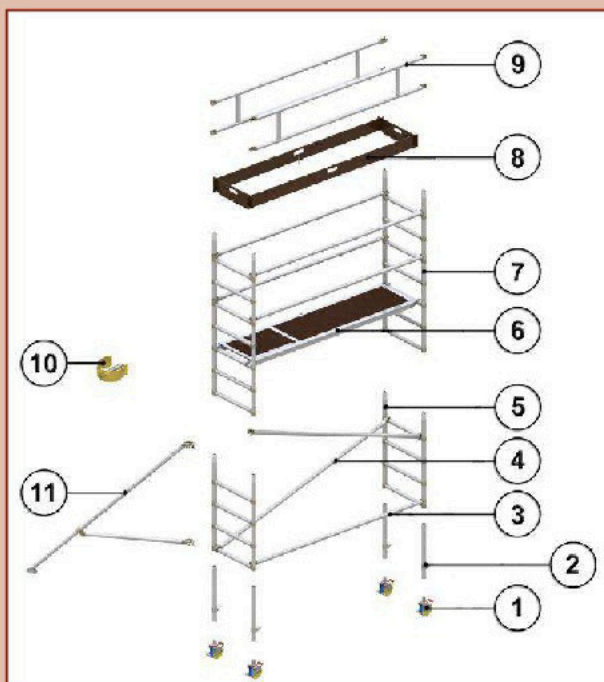

Stillasmontering

1. Hjul
2. Benjustering
3. Horisontalavstiver
4. Diagonalavstiver
5. 4-trinns ramme
6. Plattform
7. 7-trinns ramme
8. Fotlist
9. Siderekkverk
10. Låseklips
11. Støtteben

STILLAS - ENKEL BREDE 6m VIST FREMGANGSMÅTE ER FOR SPAN300 (LIKT FOR 300W)

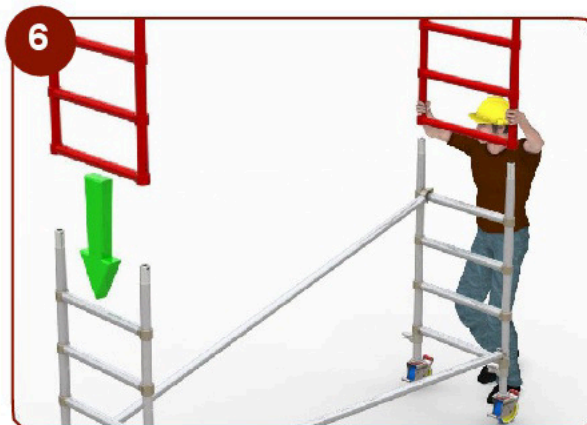
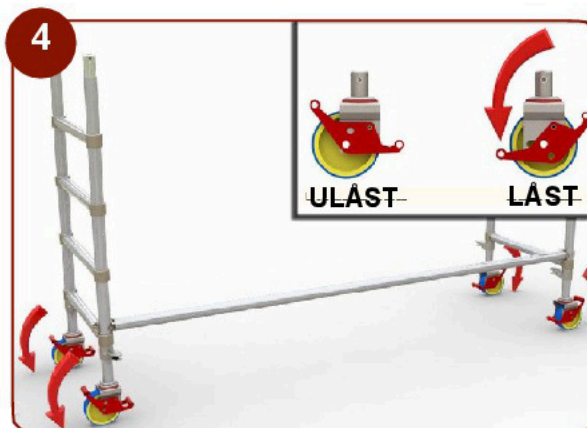
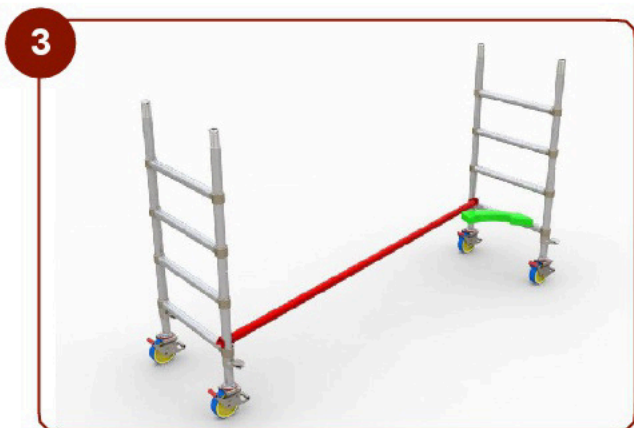
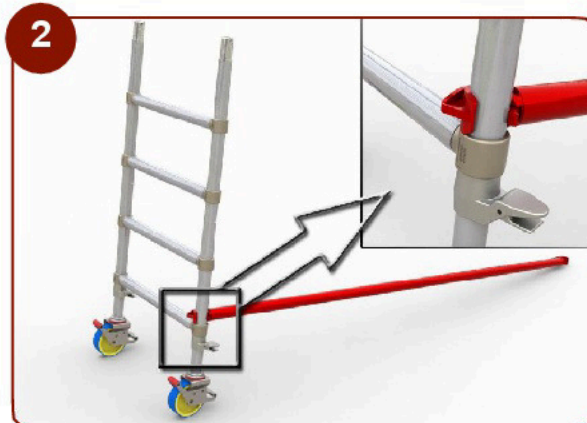
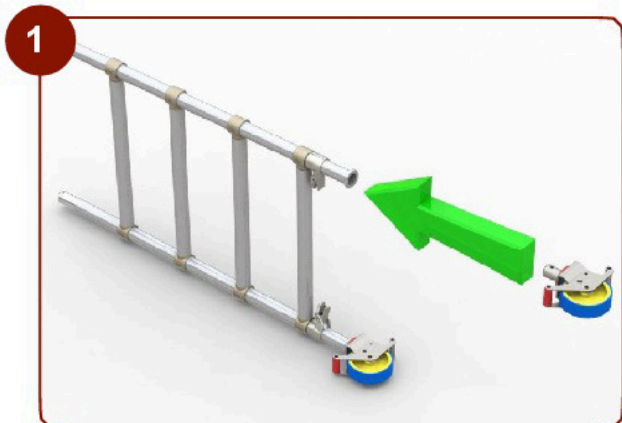

Stillas - enkel bredde 6m

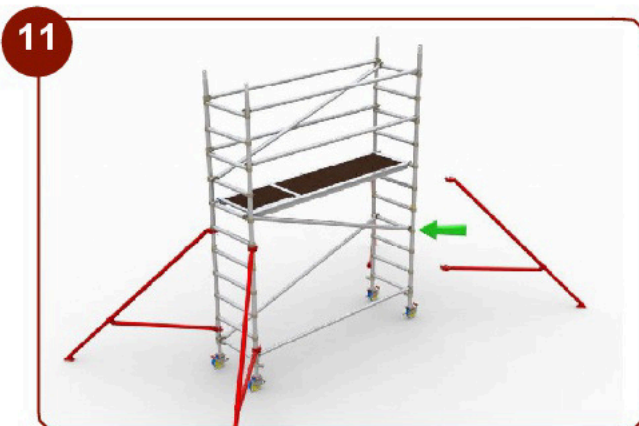
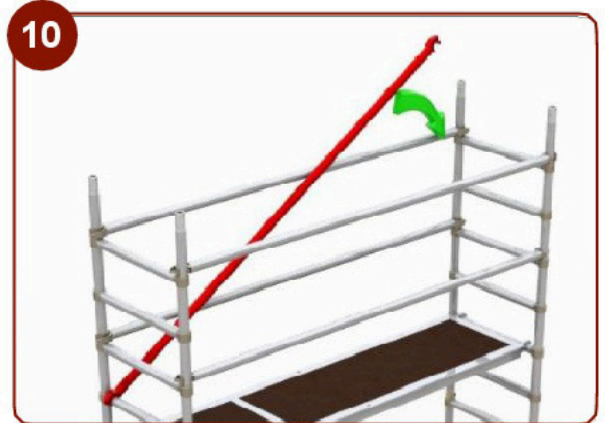

Stillas - enkel bredde 6m

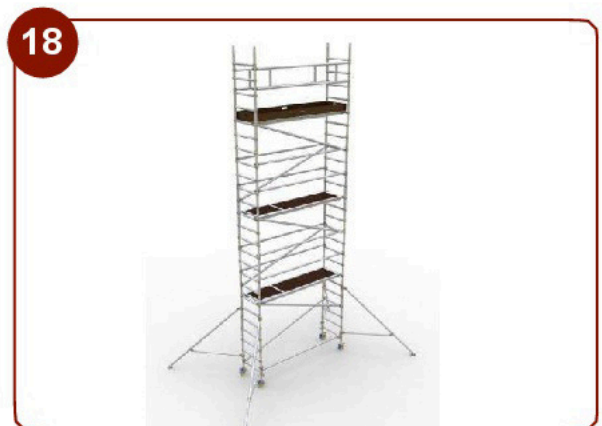
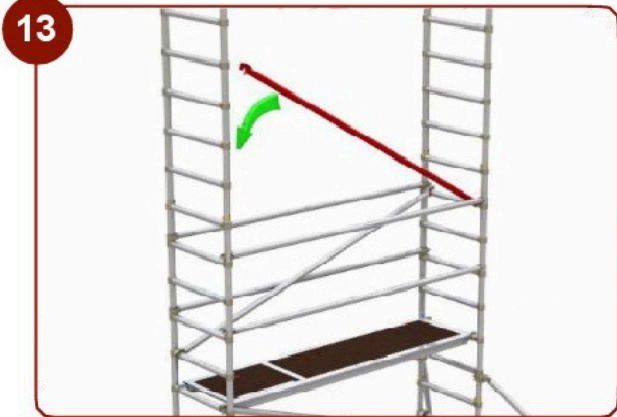

Stillas - enkel bredde 5m

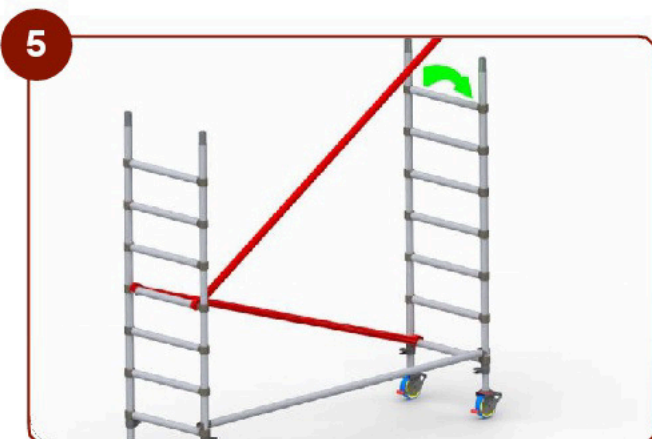
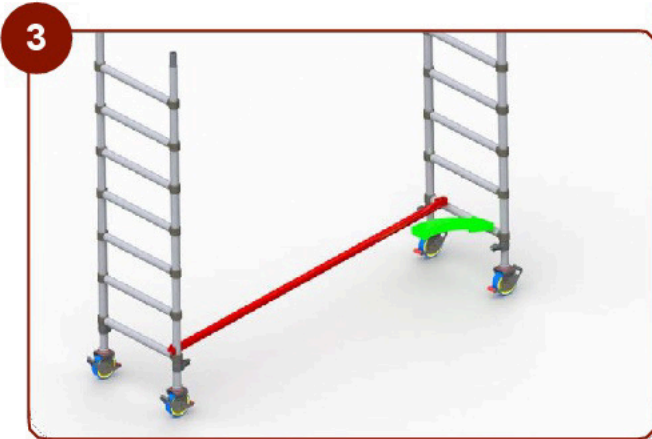
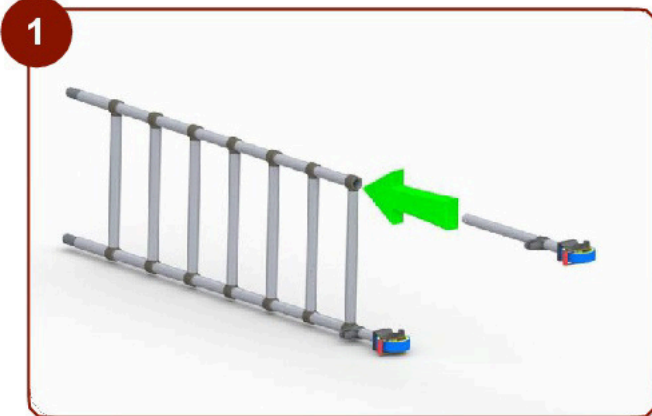

Stillas - enkel bredde 5m

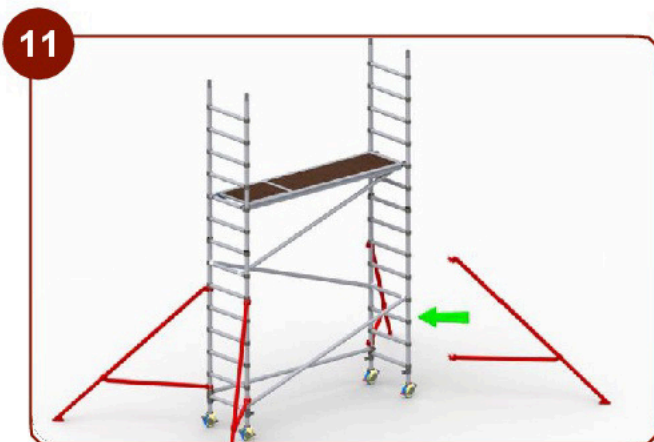
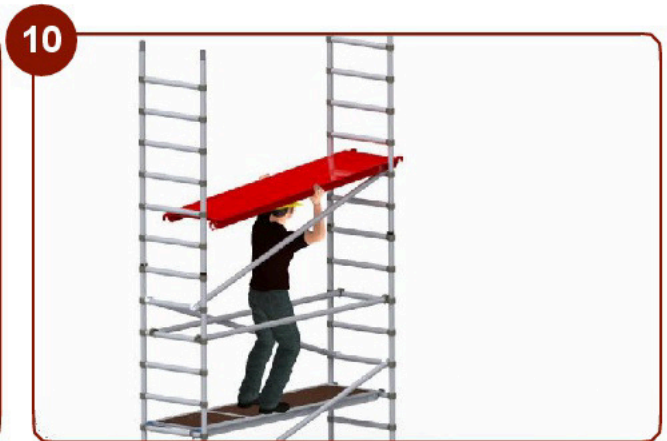
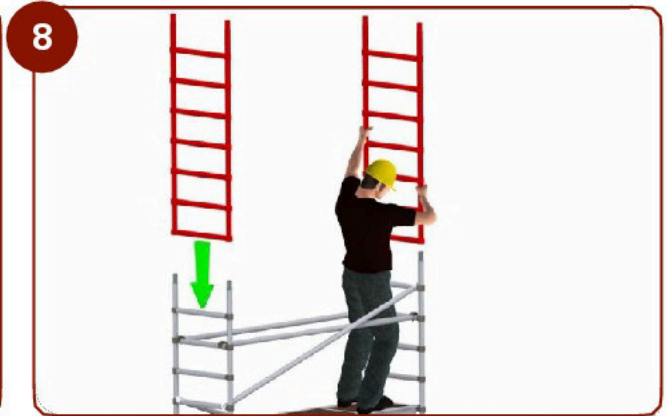

Enkelt bredde tårn 5 m

13



14



15



16



17

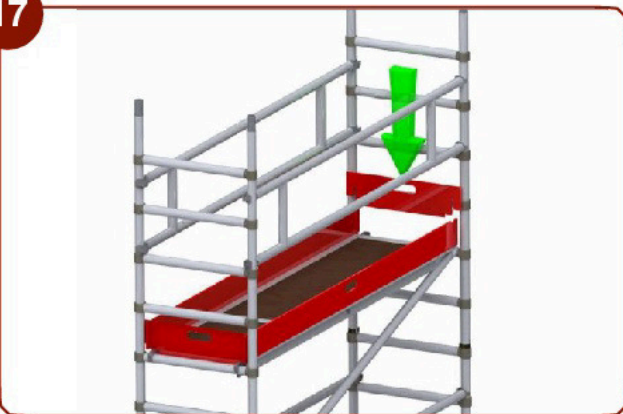

18



**DETALJERT
PRODUKTINFORMASJON**

**ALTERNATIV 3 -
SPAN300 DW VX AVSTIVET
BUNNRAMME**

Tabell over deler og mengder

Span 300 Dobbel bredde - 2m, 2,5m og 3m lengder till EN1004 og WAHR															
Plattformhøyde (m)	2m		4m		6m		8m		10m		12m				
Arbeidshøyde (m)	4m		6m		8m		10m		12m		14m				
Stillashøyde (m)	3m		5m		7m		9m		11m		13m				
Stillasvekt i kg (2 m lengde)	113		184		235		291		342		392				
Stillasvekt i kg (2,5 m lengde)	125		203		261		324		381		439				
Stillasvekt i kg (3 m lengde)	136		219		281		349		411		473				
Merk: Oppgitte plattformhøyder inkluderer 150 mm benjustering for utjevning som kan økes eller reduseres															
Beskrivelse	Vekt (kg)			2m		4m		6m		8m		10m		12m	
7-trinns ramme	11,2			2		4		6		8		10		12	
4-trinns ramme	8,5			2		2		2		2		2		2	
Plattform m/luke (2 m, 2,5 m, 3 m)	14	18	20	1		2		3		4		5		6	
Standard plattform (2, 2,5, 3 m)	14	17	20	1		1		1		1		1		1	
Horisontalavstiver (2, 2,5, 3 m)	1,7	2	2,4	1		5*		9*		13*		17*		21*	
Diagonalavstiver (2, 2,5, 3 m)	1,8	2,2	2,5			4		8		12		16		20	
Siderekkverk (2m, 2,5m, 3m)	3,8	4,4	5,2	2*		2		2		2		2		2	
Teleskop-støtteben	5,2			4		4		4							
Lange støtteben	6,8							4		4		4			
Benjustering	1,1			4		4		4		4		4		4	
Hjul / Fotplate	2,8			4		4		4		4		4		4	
Fotlistsett (2m, 2,5m, 3m)	8,7	11,5	14,4	1*		1		1		1		1		1	
VX Grunnseksjon (2m, 2,5m, 3m)	36,8	37,8	38,8	1		1		1		1		1		1	

* Inkluderer siderekkverk og fotlist på 2m plattformhøyde, i henhold til norsk regelverk.

Stillas - dobbel bredde 6m

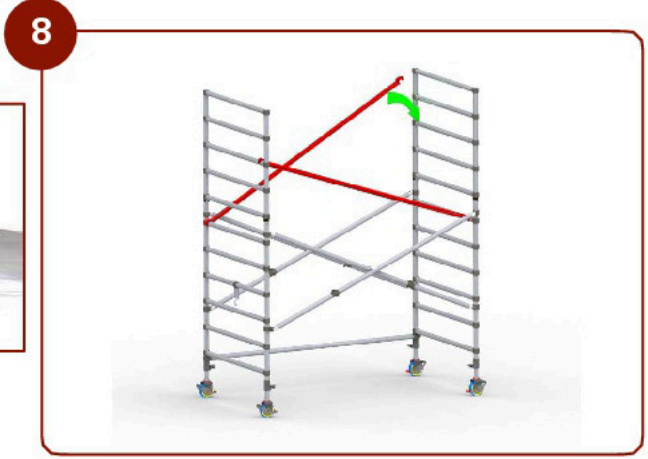
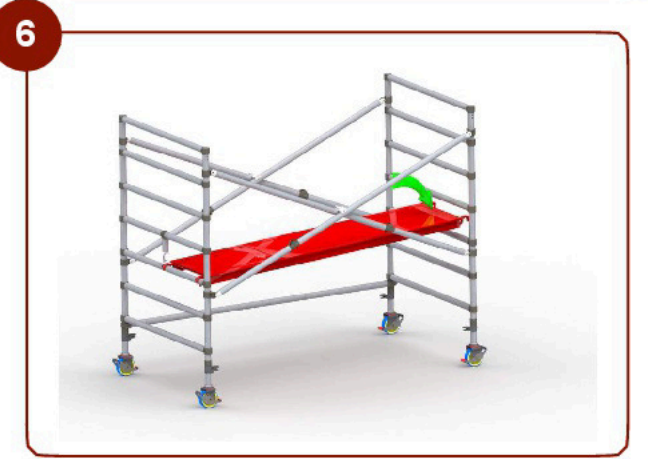
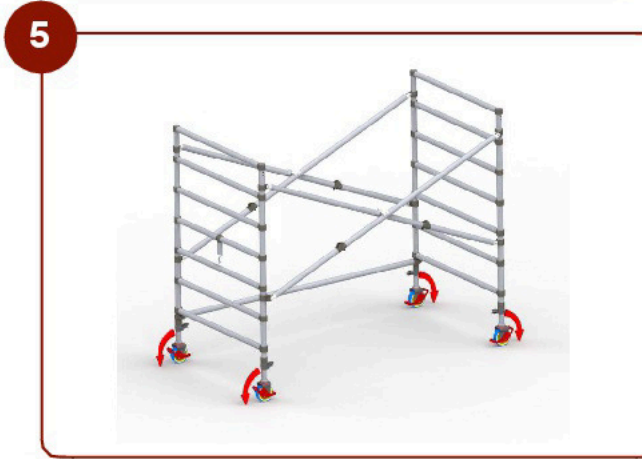
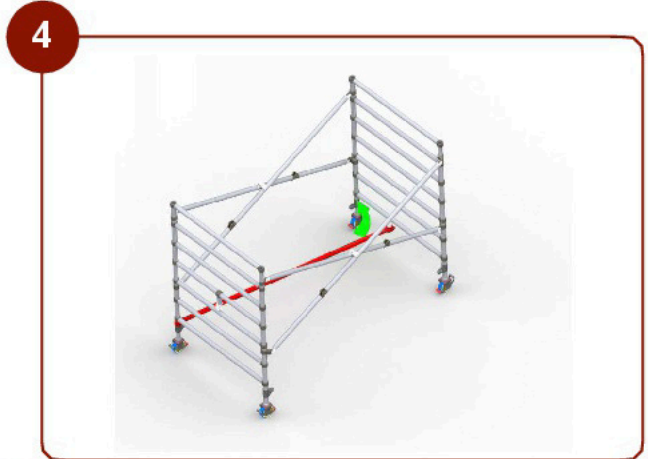
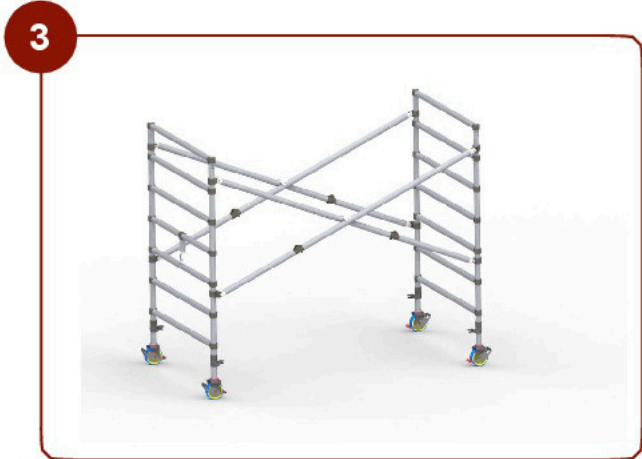
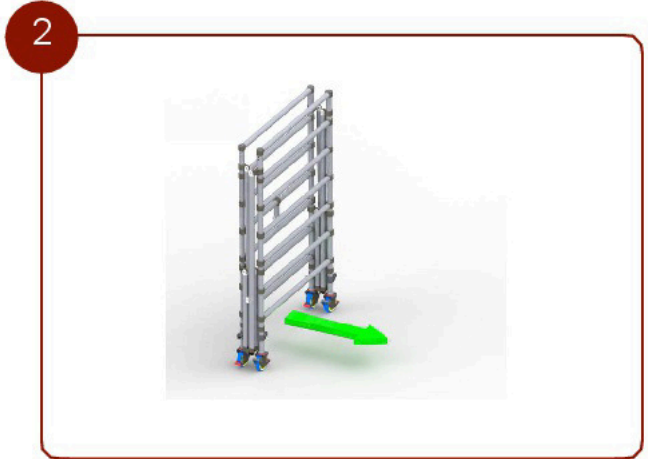
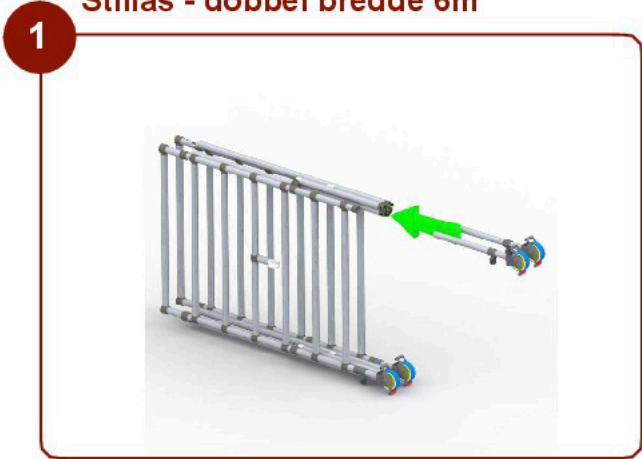

Stillas - dobbel bredde 6m

9



10

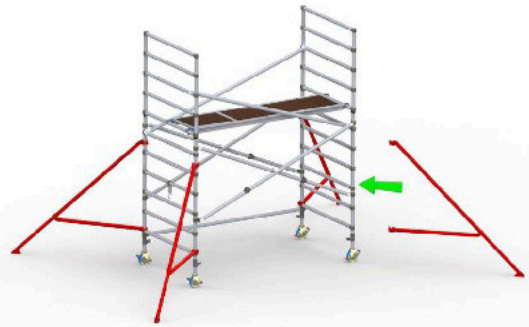

11



12



13



14



15



16



Stillas - dobbel bredde 6m

17



18

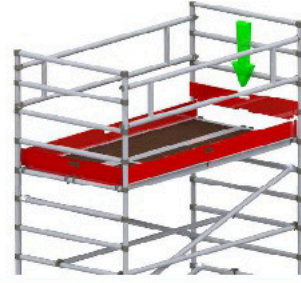

19



ALTERNATIV 3 -SPAN300 SW VX AVSTIVET BUNNRAMME

DETALJERT PRODUKTINFORMASJON

Tabell over deler og mengder

Span 300 Enkel bredde - 2m, 2,5m og 3m lengder til EN1004 og WAHR								
Plattformhøyde (m)	2m		4m		6m		8m	
Arbeidshøyde (m)	4m		6m		8m		10m	
Stillashøyde (m)	3m		5m		7m		9m	
Stillasvekt i kg (2 m lengde)	85		147		189		237	
Stillasvekt i kg (2,5 m lengde)	93		162		209		263	
Stillasvekt i kg (3 m lengde)	100		172		224		282	
Merk: Oppgitte plattformhøyder inkluderer 150 mm benjustering for utjevning som kan økes eller reduseres								
Beskrivelse	Vekt (kg)							
7-trinns ramme	8,5				2	4	6	
4-trinns ramme	5,7			2	2	2	2	
Plattform m/ luke (2 m, 2,5 m, 3 m)	14	18	20	1	2	3	4	
Horisontalavstiver (2, 2,5, 3 m)	1,7	2	2,4	1	1	1	1	
Diagonalavstiver (2, 2,5, 3 m)	1,8	2,2	2,5	*	2*	4*	6*	
Siderekker (2m, 2,5m, 3m)	3,8	4,4	5,2	2	4	6	8	
Teleskop-støtteben	5,2			4	4	4		
Lange støtteben	6,8						4	
Benjusteringer	1,1			4 *	4	4	4	
Hjul / Fotplate	2,8			4	4	4	4	
Fotlistsett (2m, 2,5m, 3m)	6,8	8,4	9,8	1	1	1	1	
VX Grunnseksjon (2m, 2,5m, 3m)	30,5	31,5	32,5	1	1	1	1	

* Inkluderer siderekker og fotlist på 2m plattformhøyde, i henhold til norsk regelverk.

Stillas - enkel bredde 6m

1

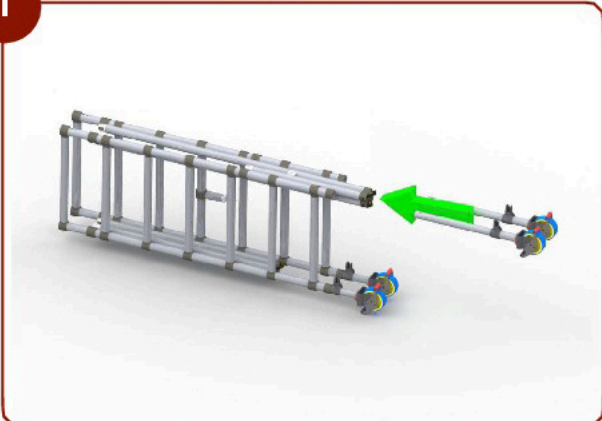

2



3



4

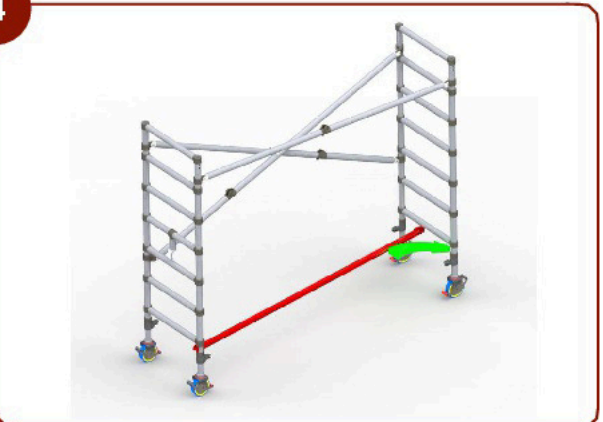

5



6

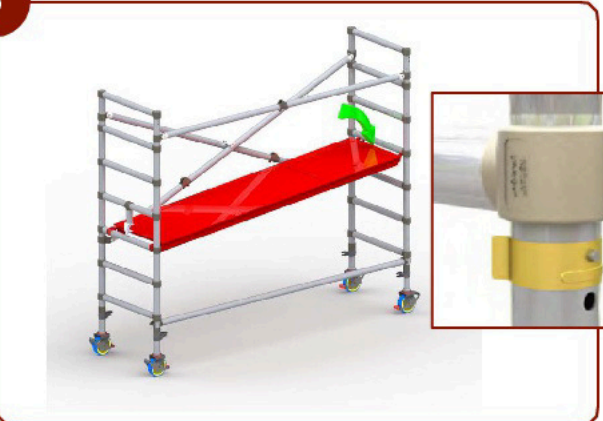

7



8



Stillas - enkel bredde 6m

9

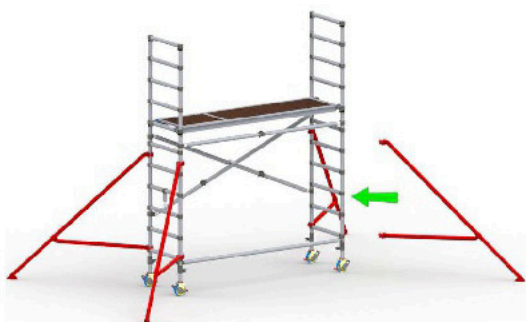

9



11



12



13



14



15



16

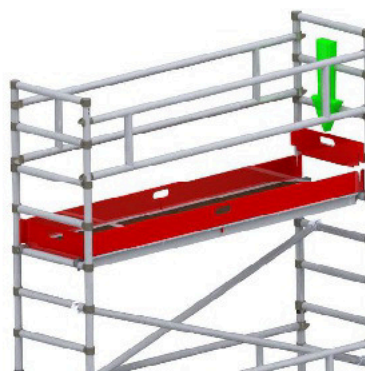

Stillas - enkel bredde 6m

17



INSTANT UPRIGHT
